

CPC 50-12

Cyclic AGM battery (600 cycles)

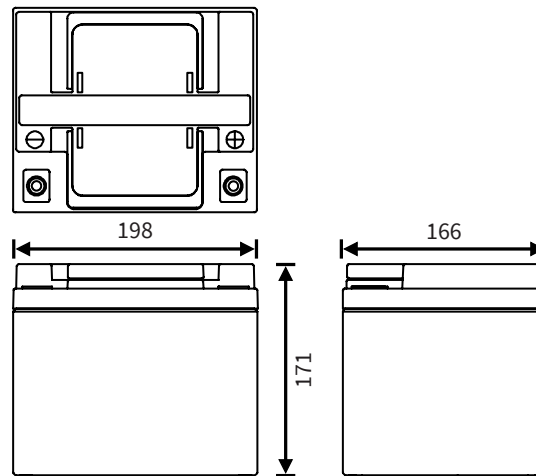

Dimensions (mm)



Standard terminal (mm)

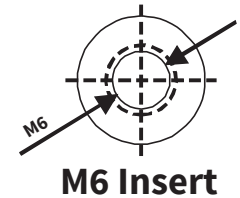

Typical applications

- Electric vehicles
- Mobility scooters
- Electric wheelchairs
- AGV and warehouse equipment
- Medical equipment
- Solar energy
- Recreational vehicles
- Marine
- Camper and caravan

Features

- Valve Regulated Lead Acid (VRLA)
- Maintenance free
- Absorbent Glass Mat Technology (AGM)
- Low self discharge
- Designed for cyclic use
- Can be discharged or stored in any position without leakage
- Battery cannot be charged while upside down
- Produced under ISO 9001 & ISO 14001

Restrictions

This battery is classified as **non spillable** and is therefore **not restricted** for transport under **ADR regulations** (road transport), **IMDG code** (sea transport) and **IATA regulations** (air transport).

Built to comply with

- DIN 43534
- IEC896-2
- BS6290-pt.4

Nominal voltage	12 V
Nominal capacity (1.70V/c, 25°C)	20Hr: 50.0 Ah
	10Hr: 45.0 Ah
	5Hr: 40.0 Ah
	2Hr: 34.0 Ah
Internal resistance	≤8.0mΩ (fully charged)
Maximum charge current	15 A
Maximum discharge current	600 A (max. 5 sec)
Number of cycles	600 (50% D.O.D.)
Float use / cyclic use	13.5 - 13.8V / 14.4 - 15.0V
Charge temperature range	-15°C ~ 40°C
Discharge temperature range	-15°C ~ 50°C
Standard terminal	Insert M6 (6 Nm torque)
Housing material	ABS (UL94-HB)
Dimensions Length	198 mm
Dimensions Width	166 mm
Dimensions Height	171 mm
Approximate Weight	14.30 kg
Packing	1 pcs / box

Recommended

Having the right battery is often just the beginning. Optimal use of a battery requires having a good battery charger, so that the user can be sure that their battery is always optimally charged and has maximum lifespan.

Cellpower offers various intelligent battery chargers, as well as battery testers, battery monitors and battery guards. All designed to easily monitor the battery quality and make sure the battery remains in the best condition possible.



Recommended for CPC 50-12: L CP 12-6 battery charger

Charge characteristics

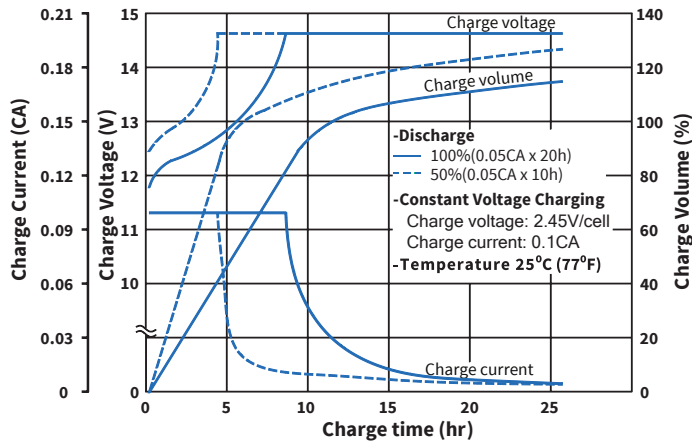

Capacity in relation to temperature

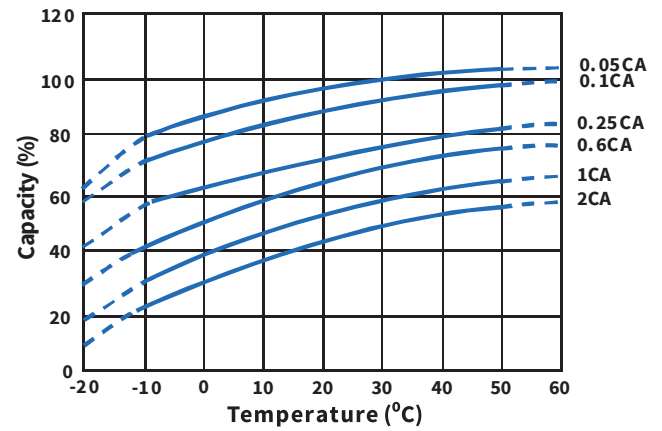

Charge voltage in relation to temperature

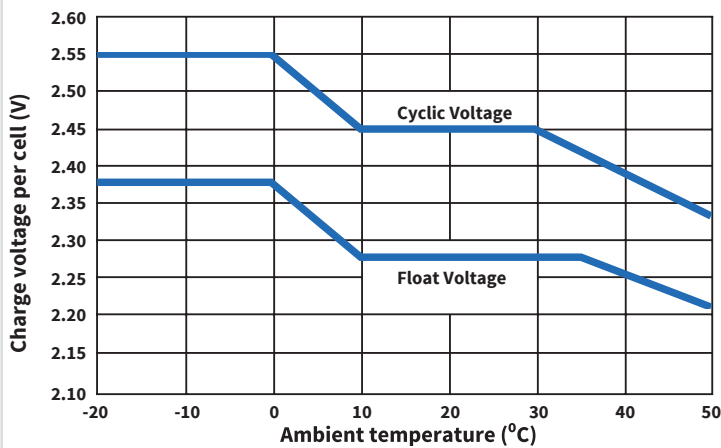

Cycle service life in relation to depth of discharge

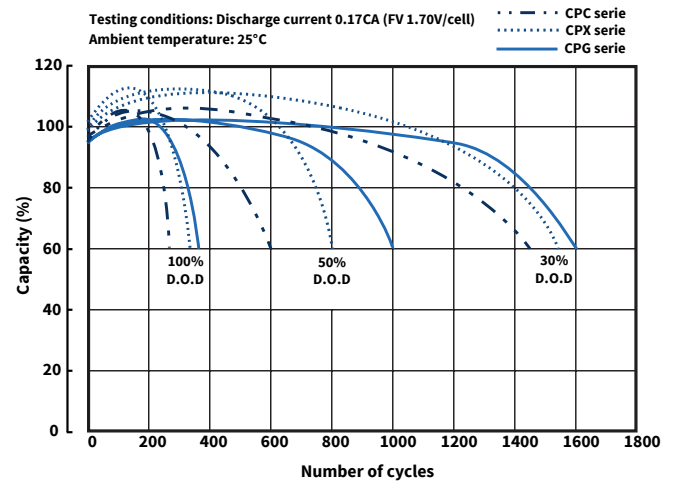

Models available

Model	Voltage	Capacity (Ah)	Dimensions (mm)	Weight (kg)
CPC 225-6	6	225	243x187x276	33.00
CPC 9-12	12	9.0	151x65x100	2.80
CPC 10-12	12	10	151x65x118	3.30
CPC 12-12	12	12	151x98x98	3.90
CPC 18-12	12	18	181x76x167	6.08
CPC 24-12	12	24	175x166x125	9.30
CPC 33-12	12	33	197x131x170	10.50
CPC 38-12	12	38	198x166x171	13.30
CPC 38-12S	12	38	197x131x168	10.70
CPC 50-12	12	50	198x166x171	14.30
CPC 55-12	12	55	226x135x214	17.00
CPC 62-12	12	62	226x135x214	18.70
CPC 75-12LW	12	75	260x170x207	24.40
CPC 80-12AJ	12	80	353x174x190	25.70
CPC 90-12	12	90	306x169x215	29.00
CPC 110-12	12	110	330x171x220	30.00
CPC 120-12	12	120	408x176x227	37.00
CPC 135-12	12	135	341x173x287	40.00
CPC 150-12	12	150	482x170x240	44.50
CPC 160-12	12	160	530x209x220	55.50
CPC 200-12	12	200	522x238x223	62.50
CPC 250-12	12	250	520x269x227	74.00

Cellpower family

Cellpower supplies a broad range of reliable AGM, GEL and Lithium batteries. Each product series has its own unique characteristics, so that there is a suitable battery for every application with its associated specific usage profile. Combined with the right Cellpower battery accessories, you are able to assemble a high-quality and reliable battery system.

The sealed, maintenance-free AGM lead battery type has a long operational lifetime. When used correctly, the Absorbent Glass Mat (AGM) technology offers dependable, lasting service. Additionally, AGM batteries exhibit very little self-discharge when compared with other lead-acid batteries. Sealed lead-acid batteries require low maintenance and do not need to be refilled with water or other liquids.

